

1 PLAN VIEW
Scale: 1/4" = 1'-0"

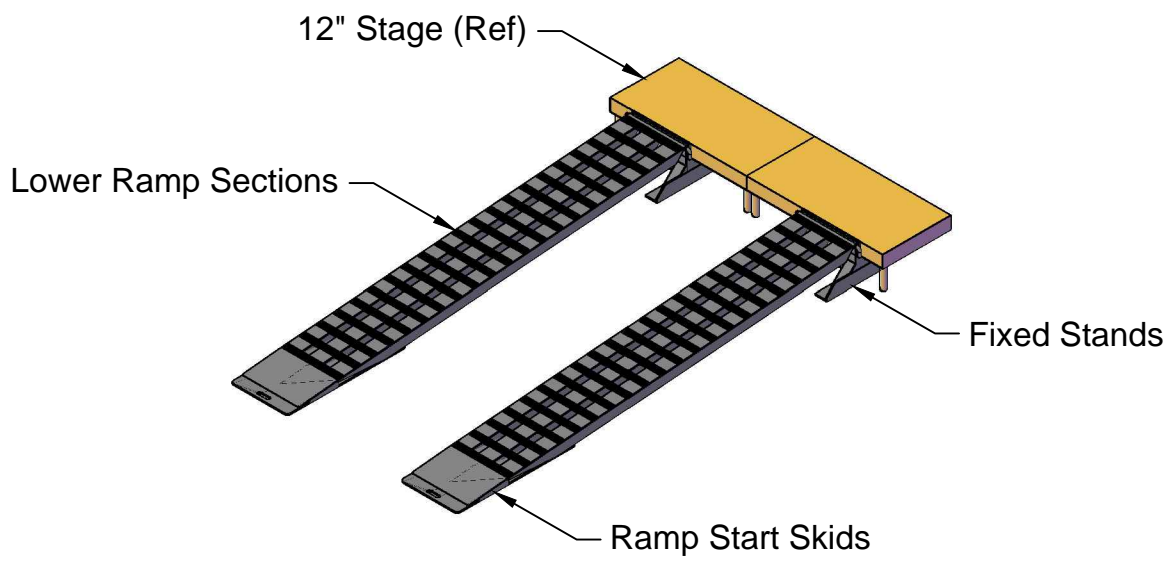

3 ISO VIEW
Scale: 1/4" = 1'-0"

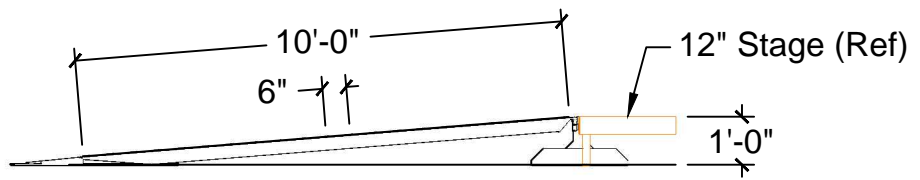

2 SIDE VIEW
Scale: 1/4" = 1'-0"

- Notes:
- 4 Loading Ramps
 - 2 Support Stands
 - 8,000LB Capacity
 - 5,000LB Weight Capacity per Axle
 - Support Stands are Fixed to 12"
 - No Side Curbs

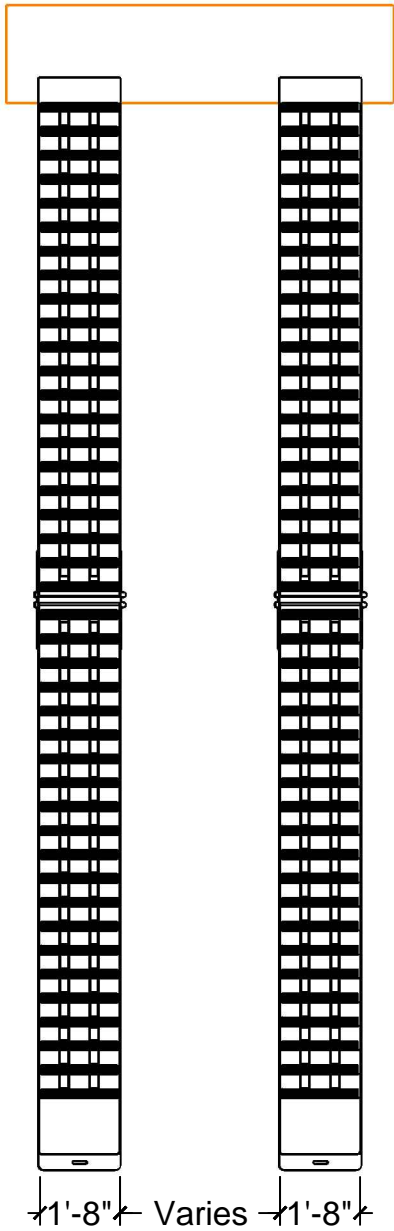

1 PLAN VIEW
Scale: 1/4" = 1'-0"

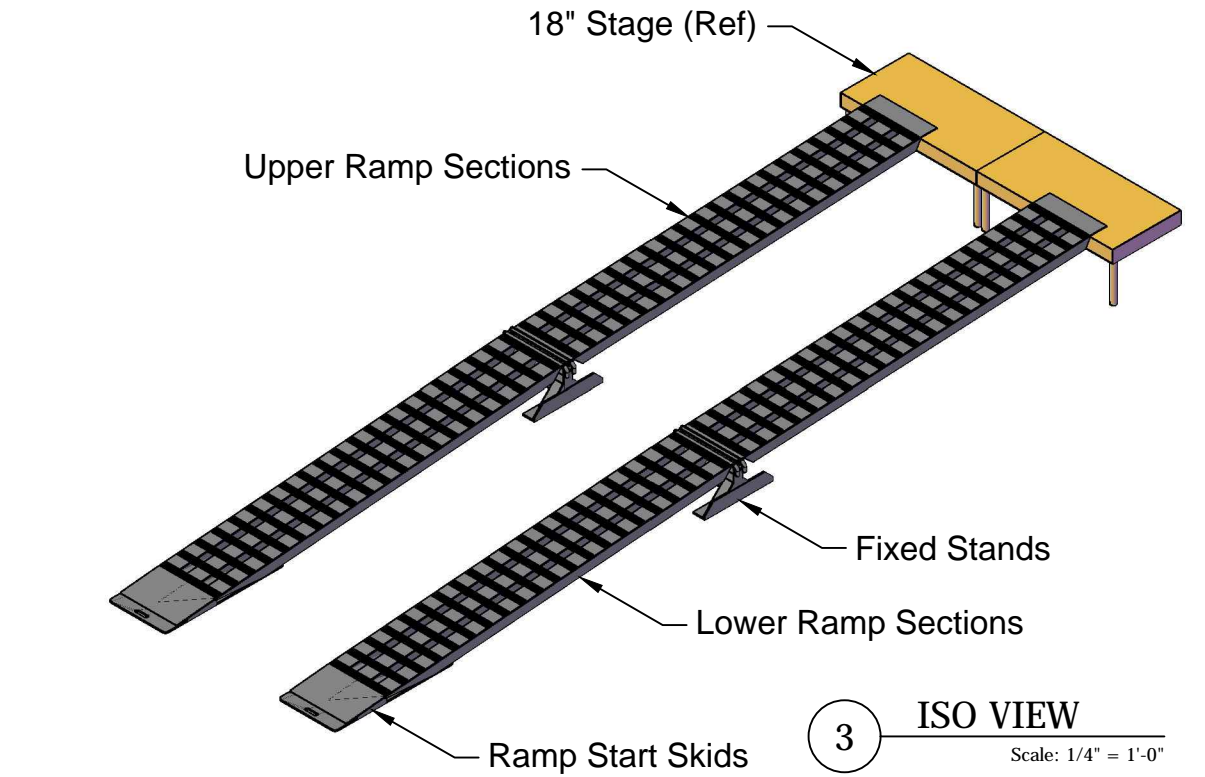

3 ISO VIEW
Scale: 1/4" = 1'-0"

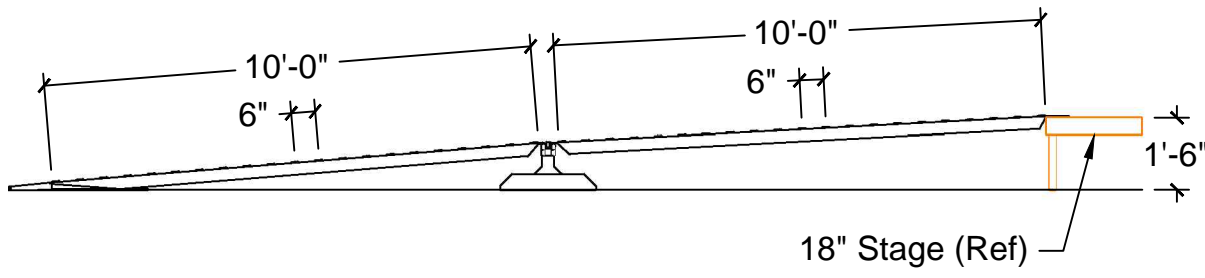

2 SIDE VIEW
Scale: 1/4" = 1'-0"

- Notes:
- 4 Loading Ramps
 - 2 Support Stands
 - 8,000LB Capacity
 - 5,000LB Weight Capacity per Axle
 - Support Stands are fixed to 12"
 - No Side Curbs

BUNGALOW
scenic studios

3901 Silver Star Road • Orlando, Florida 32808 • 407-401-5191

Disclaimer: Design and Drawing are property of Bungalow Product Studios. Drawing cannot be reproduced, copied or used for construction without written permission from Bungalow Scenic Studios.

Description:
Web_Car Ramp (Fixed 18In Stage)

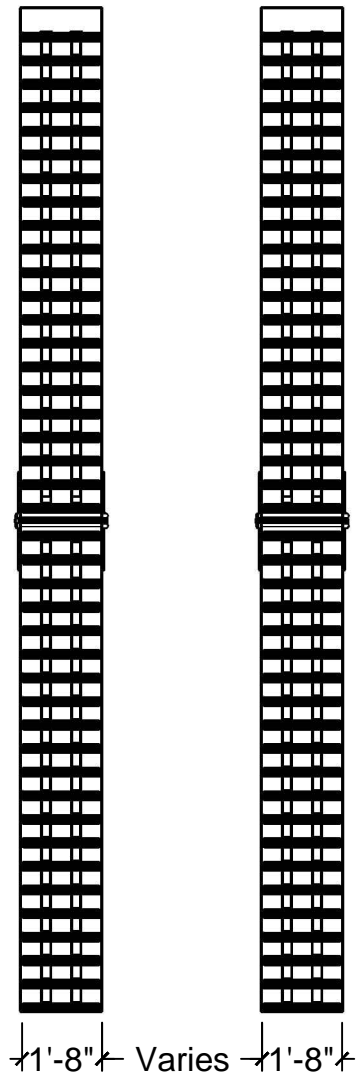

1 PLAN VIEW
Scale: 1/4" = 1'-0"

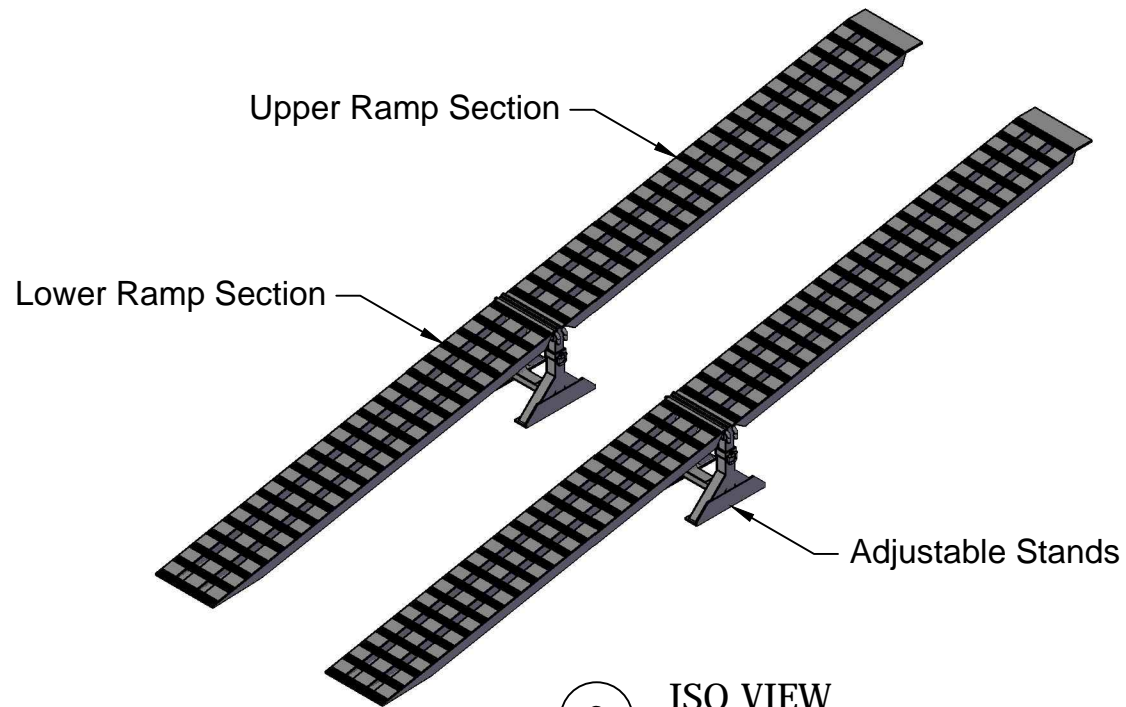

3 ISO VIEW
Scale: 1/4" = 1'-0"

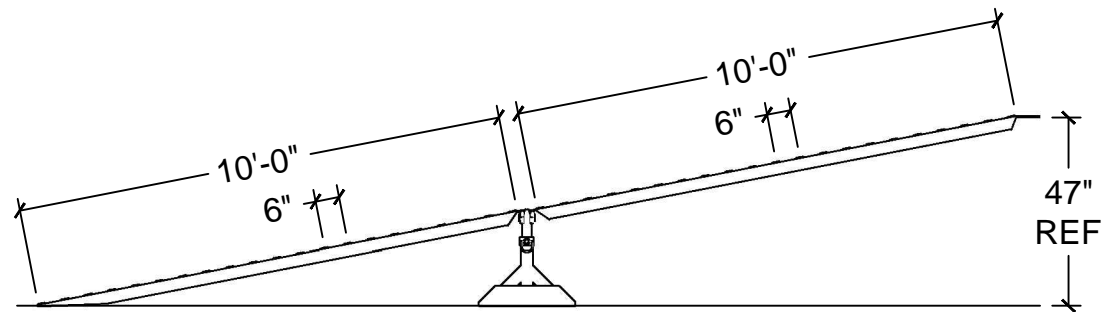

2 SIDE VIEW
Scale: 1/4" = 1'-0"

- Notes:
- 4 Loading Ramps
 - 2 Support Stands
 - 8,000LB Capacity
 - 5,000LB Weight Capacity per Axle
 - Support Stands are adjustable from 24"–30"
 - No Side Curbs